



CONTACTEER HET MRCC: VHF 16 / 67, TEL 059 /70 11 00

VERMELD POSITIE, AFMETINGEN & TYPE (ZIE KAART)

NEEM FOTO'S INDIEN MOGELIJK EN MAIL NAAR => mrcc@mrcc.be

OP DEK?

VRIJ HOUDEN VAN HITTE EN TRILLING, BEWEGING BELETTEN, AFDEKKEN EN OP 4000 M VAN DE KUST KOMEN

BUITEN BOORD?

OVERBOORD ZETTEN (NAAR ONDIEPER WATER) EN *BEBAKENEN!*

KUST: 4000 M - PIJPLIJNEN: 2000 M

KABELS, MEETPALEN, WRAKKEN: 1000 M

BOEIEN: 200 M

**ZIE OOK
BAZ NR 1**

ZEEMIJNEN GROND (afmetingen ± tussen 1m20 en 2m50)

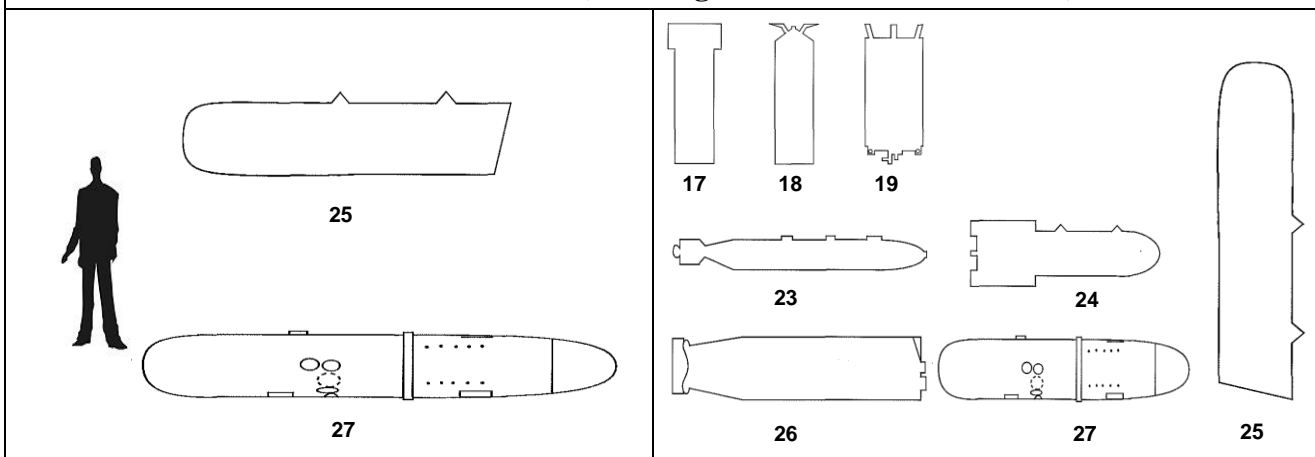

ZEEMIJNEN VERANKERD (afmetingen ± Ø tussen 60cm en 1m50)

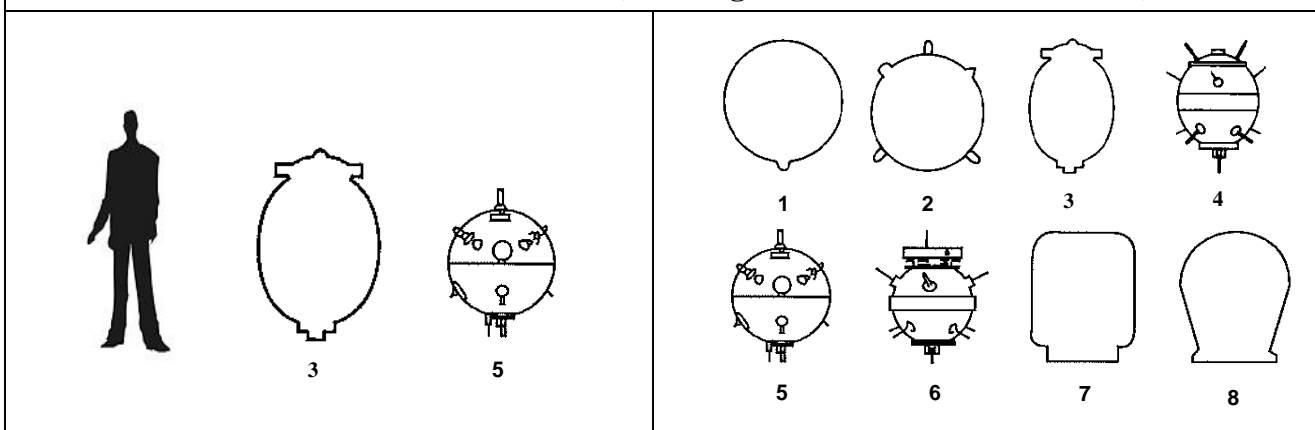

STRANDMIJNEN (afmetingen ± tussen 50cm en 1m50)

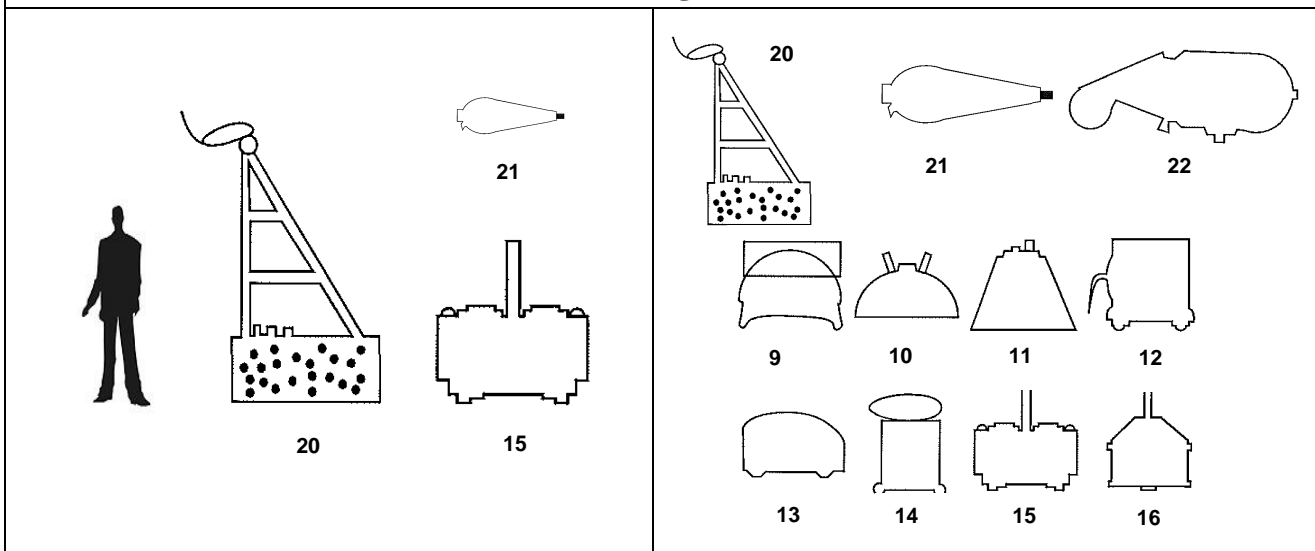

DIEPTEBOMMEN (afmetingen ± tussen 60cm en 1m20)

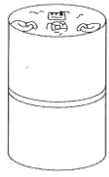

42

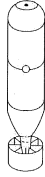

46

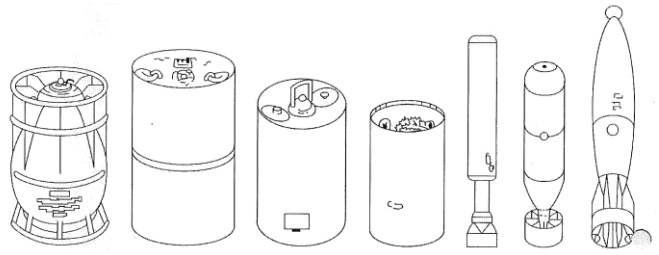

41

42

43

44

45

46

47



48

49

50

51

VLIEGTUIGBOMMEN (afmetingen ± tussen 20cm en 120cm)

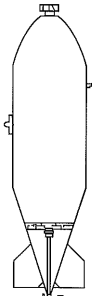

29

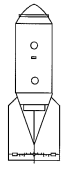

31

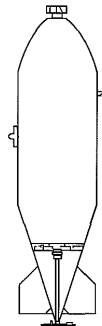

29

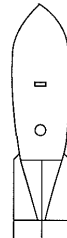

30

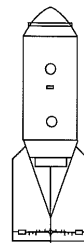

31



32



33

TORPEDO'S (afmetingen ± tussen 1m50 en 4m)



36

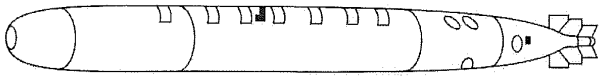

40

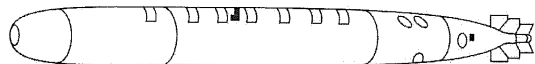
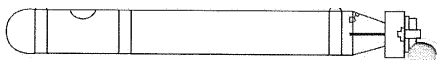

36

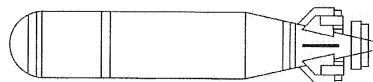

37

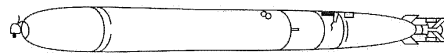

38

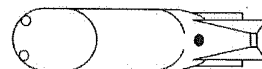

39

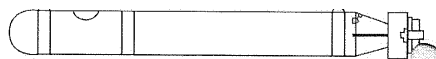

40

DIVERSE KLEINE MUNITIES (afmetingen ± tussen 20cm en 1m20)



58



52



28

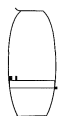

34



35

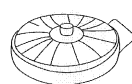

52

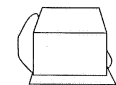

53

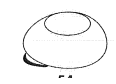

54

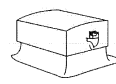

55

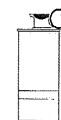

56



57



58



35



34

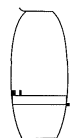

28